

"P" SERIES - Sealed Sapphire Trimmer Capacitors

Voltronics "P" line of sapphire subminiature trimmer capacitors is a unique design.

The trimmers have high Q, zero temperature coefficient, and are internally O-ring sealed to keep out flux and cleaning fluid. Yet, sizes are the same as the MIL unsealed styles. The tuning screw does not move in and out, and RF current does not run along it.

Sapphire is ideal for precision trimmer capacitors. It's dielectric constant does not change with frequency, and its loss constant is extremely

stable, measuring below 0.0003 up to 10 GHz. Sapphire is chemically inert, totally moisture resistant, and mechanically strong.

THE "P" LINE OFFERS:

- High Q, low temperature coefficient, and internal seal
- Low self-inductance for use to 10 GHz
- Interchangeability with unsealed designs
- Long life, no measurable tuning noise



HIGH FREQUENCY DATA*

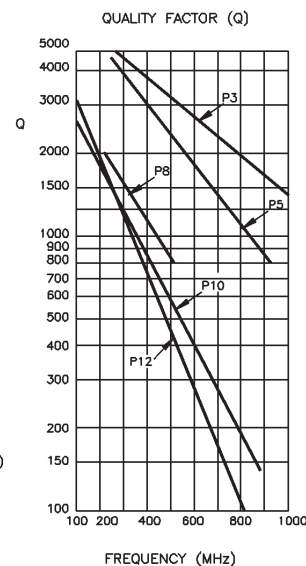
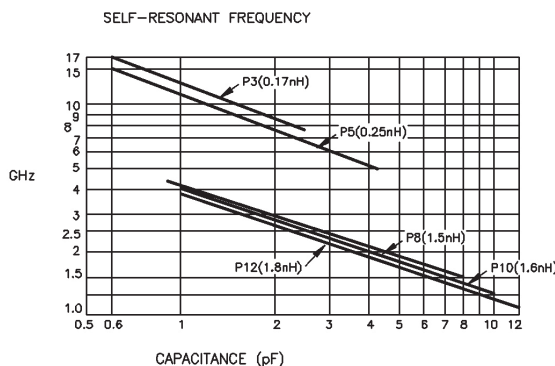

*This high frequency data was taken on a Boonton Model 34A Resonant Coaxial-line with the parts set at their maximum rated capacitance values. Connections to the parts were made directly on the body of the capacitors

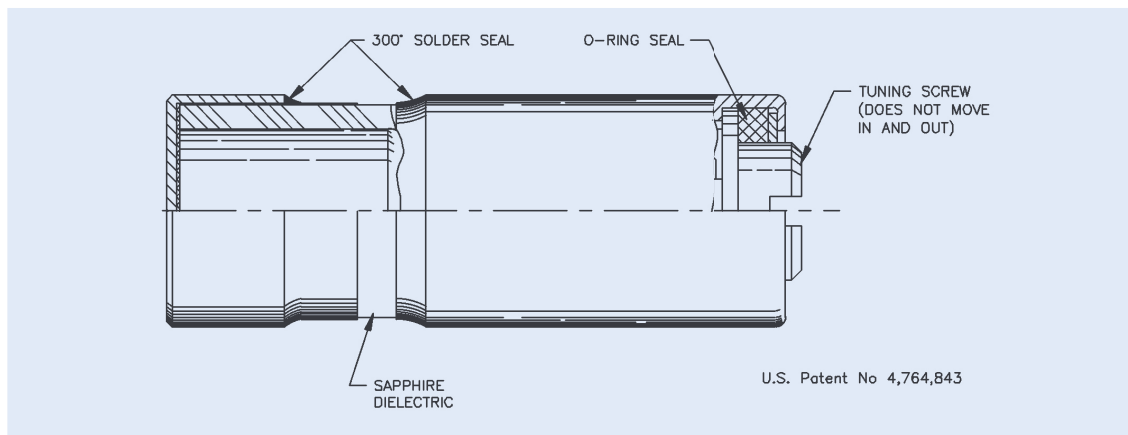

GENERAL SPECIFICATIONS

- DC Working Voltage: 500
- DC Withstanding Voltage: 1000
- Seal: Internal O-ring
- Operating Temperature: -55 °C to +125 °C
- Mechanical Shock: 100 g's 6 ms
- Vibration: 60 g's, 10-2000 Hz

- Tuning Torque: 0.2 to 2.0 inch ounces
- Temperature Coefficient:

P3	0 ± 50 ppm/°C
P5	0 ± 50 ppm/°C
P8	0 ± 75 ppm/°C
P10	100 ± 100 ppm/°C
P12	100 ± 100 ppm/°C

FIG. 1

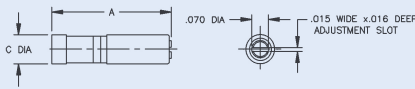

FIG. 2

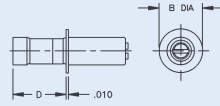

FIG. 3

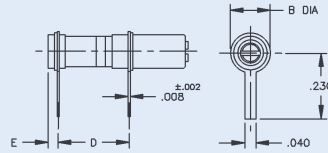

FIG. 4

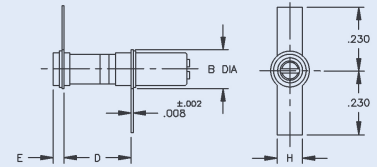

FIG. 5

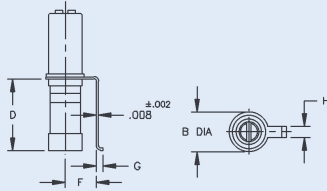

FIG. 6

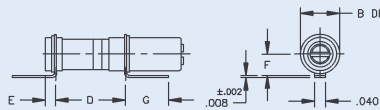
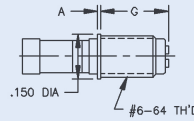
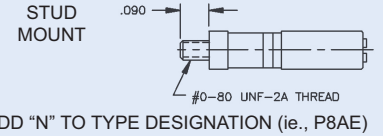

FIG. 7



Optional Configurations



ADD "N" TO TYPE DESIGNATION (ie., P8AE)

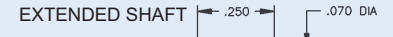

ADD "E" TO TYPE DESIGNATION (ie., P8AE)

IN .002 .005 .008 .010 .014 .015 .018 .020 .025 .034 .036 .040 .045 .047 .056 .060 .070 .075 .082 .090 .093 .094 .100 .110 .118 .125 .130 .140 .148 .150 .160 .183 .190 .230 .240 .245 .250 .329 .495
MM .05 .13 .20 .25 .36 .38 .46 .51 .64 .86 .91 .102 .114 .119 .142 .152 .178 .191 .208 .229 .236 .239 .254 .279 .300 .318 .330 .356 .376 .381 .406 .465 .483 .584 .610 .622 .635 .836 12.57

Type	Fig.	Capacitance Range (pF)		Q (Min.) 250 MHz	Tolerances (where not specified) ± .016							
		From Below	To Above		A (max)	B DIA.	C± .005	D± .010	E± .010	F	G	H± .005
P3A	1	0.6	2.5	4,000	.240	-	.118	-	-	-	-	-
P5A	1	0.6	4.5	3,000	.329	-	.118	-	-	-	-	-
P8A	1	0.8	8.0	1,500	.495	-	.118	-	-	-	-	-
P10A	1	1.0	10.0	1,250	.329	-	.118	-	-	-	-	-
P12A	1	1.0	12.0	1,250	.495	-	.118	-	-	-	-	-
P3D	2	0.6	2.5	4,000	.240	.190	.118	.100	-	-	-	-
P5D	2	0.6	4.5	3,000	.329	.190	.118	.150	-	-	-	-
P8D	2	0.8	8.0	1,500	.495	.190	.118	.230	-	-	-	-
P10D	2	1.0	10.0	1,250	.329	.190	.118	.150	-	-	-	-
P12D	2	1.0	12.0	1,250	.495	.190	.118	.230	-	-	-	-
P3B	3	0.6	2.5	4,000	.240	.140	.118	.082	.014	-	-	-
P5B	3	0.6	4.5	3,000	.329	.140	.118	.130	.034	-	-	-
P8B	3	0.8	8.0	1,500	.495	.140	.118	.250	.036	-	-	-
P10B	3	1.0	10.0	1,250	.329	.140	.118	.130	.034	-	-	-
P12B	3	1.0	12.0	1,250	.495	.140	.118	.250	.036	-	-	-
P3C	4	0.6	2.5	4,000	.240	.140	.118	.056	.018	-	-	.093
P5C	4	0.6	4.5	3,000	.329	.140	.118	.100	.060	-	-	.093
P8C	4	0.8	8.0	1,500	.495	.140	.118	.150	.060	-	-	.093
P10C	4	1.0	10.0	1,250	.329	.140	.118	.100	.060	-	-	.093
P12C	4	1.0	12.0	1,250	.495	.140	.118	.150	.060	-	-	-
P3F	5	0.6	2.5	4,000	.240	.140	.118	.090	-	.110	.025	.04
V6064	5	0.6	2.5	4,000	.240	.140	.118	.090	-	.110	.025	.09
V6034	5	0.6	4.5	3,000	.329	.140	.118	.160	-	.110	.025	.09
V6047	5	0.6	4.5	3,000	.329	.140	.118	.160	-	.140	.100	.04
P5F	5	0.6	4.5	3,000	.329	.140	.118	.160	-	.110	.025	.04
P8F	5	0.8	8.0	1,500	.495	.140	.118	.250	-	.110	.025	.04
P10F	5	1.0	10.0	1,250	.329	.140	.118	.160	-	.110	.025	.04
P12F	5	1.0	12.0	1,250	.495	.140	.118	.250	-	.110	.025	.04
P3J	6	0.6	2.5	4,000	.240	.140	.118	.082	.014	.070	.160	-
P5J	6	0.6	4.5	3,000	.329	.140	.118	.130	.034	.070	.160	-
P8J	6	0.8	8.0	1,500	.495	.140	.118	.250	.036	.070	.160	-
P10J	6	1.0	10.0	1,250	.329	.140	.118	.130	.034	.070	.160	-
P12J	6	1.0	12.0	1,250	.495	.140	.118	.250	.036	.087	.125	-
P3M	7	0.6	2.5	4,000	.240	-	.118	-	-	-	.125	-
P5M	7	0.6	4.5	3,000	.329	-	.118	-	-	-	.160	-
P8M	7	0.8	8.0	1,500	.495	-	.118	-	-	-	.230	-
P10M	7	1.0	10.0	1,250	.329	-	.118	-	-	-	.160	-

NOTE: For diameter and length dimensions on figures 2-7, see figure 1.